



CATÁLOGO 2020

BASES
METÁLICAS



METALYA

WWW.METALYA.MX
VENTAS@METALYA.MX
(81) 8479 0480

CATÁLOGO 2020

CUNEO

- > Base metálica Cuneo fabricada con tubo cónico de 2" en Cal. 18
- > Ménsulas angulares Cal. 14 con preparación para recibir travesaño
- > Soldada con micro alambre y terminada en pintura en polvo electrostática con vista decorativa de MDF
Remates plásticos y niveladores para ajuste de altura
- > Larguero metálico con ranura central para conducción de cableado

MEDIDA SUGERIDA DE CUBIERTA: COLORES DISPONIBLES:

1.20 FR X .70 FO

1.50 FR X .70 FO

1.80 FR X .70 FO

1.80 FR X .80 FO

 Gris Claro

 Gris Oxford

 Negro

 Blanco



CATÁLOGO 2020

NOBI



- › Base metálica Nobi fabricada con tubo de 1 ½" en Cal. 18
- › Ménsulas angulares Cal. 14 con preparación para recibir travesaño
- › Soldada con micro alambre y terminada en pintura en polvo electrostática con vista decorativa de MDF
- › Remates plásticos y niveladores para ajuste de altura
- › Larguero metálico con ranura central para conducción de cableado

MEDIDA SUGERIDA DE CUBIERTA: COLORES DISPONIBLES:

1.20 FR X .70 FO

1.50 FR X .70 FO

1.80 FR X .70 FO

1.80 FR X .80 FO

 Gris Claro

 Gris Oxford

 Negro

 Blanco

CATÁLOGO 2020

DEAL

- > Base metálica Deal fabricada con perfil de 2 ¼" x ¾" en Cal. 18
- > Ménsulas angulares Cal.14 con preparación para recibir travesaño
- > Soldada con micro alambre y terminada en pintura en polvo electrostática
- > Remates plásticos y niveladores para ajuste de altura
- > Larguero metálico con ranura central para conducción de cableado

MEDIDA SUGERIDA DE CUBIERTA: COLORES DISPONIBLES:

1.20 FR X .60 FO

1.50 FR X .60 FO

1.80 FR X .70 FO

1.80 FR X .80 FO

 Gris Claro

 Gris Oxford

 Negro

 Blanco







CATÁLOGO 2020

ONIX

- › Base metálica Ónix fabricada con perfil de 3 x 1 ½" en Cal. 18
- › Ménsulas angulares Cal. 14 con preparación para recibir travesaño
- › Soldada con micro alambre y terminada en pintura en polvo electrostática
- › Remates plásticos y niveladores para ajuste de altura
- › Larguero metálico con ranura central para conducción de cableado

MEDIDA SUGERIDA DE CUBIERTA: COLORES DISPONIBLES:

1.20 FR X .60 FO
1.50 FR X .60 FO
1.50 FR X .70 FO
1.80 FR X .70 FO
1.80 FR X .80 FO

 Gris Claro
 Gris Oxford
 Negro
 Blanco

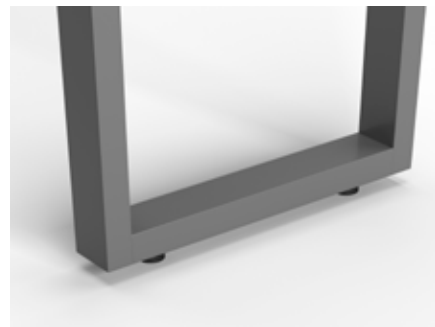

CATÁLOGO 2020

LERIDA

- › Base metálica Lérica fabricada con perfil de 2" x 1 ¼" en Cal. 18 con tubos de 2"
- › Ménsulas angulares Cal. 14 con preparación para recibir travesaño
- › Soldada con micro alambre y terminada en pintura en polvo electrostática
- › Vistas decorativas en MDF, remates plásticos y niveladores para el ajuste de altura
- › Larguero metálico con ranura central para conducción de cableado

MEDIDA SUGERIDA DE CUBIERTA: COLORES DISPONIBLES:

1.20 FR X .60 FO

1.50 FR X .60 FO

1.80 FR X .70 FO

1.80 FR X .80 FO

 Gris Claro

 Gris Oxford

 Negro

 Blanco

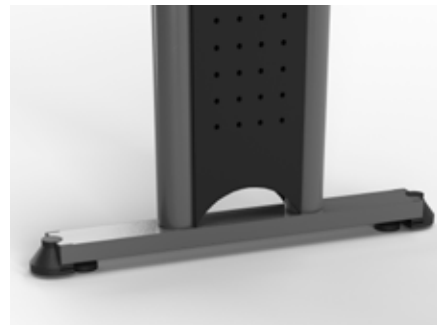

CATÁLOGO 2020

SQUARE

- > Base metálica Square fabricada con perfil de 2x2" y 2x1" en Cal. 18
- > Ménsulas angulares Cal. 14 con preparación para recibir travesaño
- > Soldada con microalambre y terminada en pintura en polvo electrostática
- > Remates plásticos y niveladores para ajuste de altura
- > Larguero metálico con ranura central para conducción de cableado

MEDIDA SUGERIDA DE CUBIERTA: COLORES DISPONIBLES:

1.20 FR X .60 FO

1.50 FR X .60 FO

1.80 FR X .70 FO

1.80 FR X .80 FO

 Gris Claro

 Gris Oxford

 Negro

 Blanco



CATÁLOGO 2020

STAPLE

- > Base metálica Staple fabricada con perfil de 2 x 2" en Cal. 18
- > Ménsulas angulares Cal. 14 con preparación para recibir travesaño
- > Soldada con microalambre y terminada en pintura en polvo electrostática
- > Remates plásticos y niveladores para ajuste de altura
- > Larguero metálico con ranura central para conducción de cableado

MEDIDA SUGERIDA DE CUBIERTA: COLORES DISPONIBLES:

1.20 FR X .60 FO

1.50 FR X .60 FO

1.80 FR X .70 FO

1.80 FR X .80 FO

 Gris Claro

 Gris Oxford

 Negro

 Blanco



CATÁLOGO 2020

CORNER

- > Base metálica Corner fabricada con perfil de 2 x 1" y 2 x 2" en Cal. 18
- > Ménsulas angulares Cal. 14 con preparación para recibir travesaño
- > Soldada con microalambre y terminada en pintura en polvo electrostática
- > Remates plásticos y niveladores para ajuste de altura
- > Larguero metálico con ranura central para conducción de cableado

MEDIDA SUGERIDA DE CUBIERTA: COLORES DISPONIBLES:

1.20 FR X .60 FO

1.50 FR X .60 FO

1.80 FR X .70 FO

1.80 FR X .80 FO

 Gris Claro

 Gris Oxford

 Negro

 Blanco



CATÁLOGO 2020

MURCIA

- › Base metálica Murcia fabricada con perfil de 4 x 1 ½" en Cal. 18 y tubo de 1 ¼" ced. 30
- › Ménsulas angulares Cal. 14 con preparación para recibir travesaño
- › Soldada con microalambre y terminada en pintura en polvo electrostática
- › Remates plásticos y niveladores para ajuste de altura
- › Larguero metálico con ranura central para conducción de cableado

MEDIDA SUGERIDA DE CUBIERTA:

COLORES DISPONIBLES:

1.20 FR X .60 FO

1.50 FR X .60 FO

1.80 FR X .70 FO

1.80 FR X .80 FO

 Gris Claro

 Gris Oxford

 Negro

 Blanco



CATÁLOGO 2020

NOVA



- > Base metálica Nova fabricada con perfil de 4 x 1 ½" y 2 x 2" en Cal. 18
- > Ménsulas angulares Cal. 14 con preparación para recibir travesaño
- > Soldada con microalambre y terminada en pintura en polvo electrostática
- > Remates plásticos y niveladores para ajuste de altura
- > Larguero metálico con ranura central para conducción de cableado

MEDIDA SUGERIDA DE CUBIERTA:

COLORES DISPONIBLES:

1.50 FR X .70 FO

1.80 FR X .70 FO

1.80 FR X .80 FO

 Gris Claro

 Gris Oxford

 Negro

 Blanco

CATÁLOGO 2020

ROME

- > Base metálica Rome fabricada con perfil de 2 x 2" en Cal. 18
- > Ménsulas angulares Cal. 14 con preparación para recibir travesaño
- > Soldada con microalambre y terminada en pintura en polvo electrostática
- > Remates plásticos y niveladores para ajuste de altura
- > Larguero metálico con ranura central para conducción de cableado

MEDIDA SUGERIDA DE CUBIERTA:

COLORES DISPONIBLES:

1.20 FR X .60 FO

1.50 FR X .60 FO

1.80 FR X .70 FO

1.80 FR X .80 FO

 Gris Claro

 Gris Oxford

 Negro

 Blanco

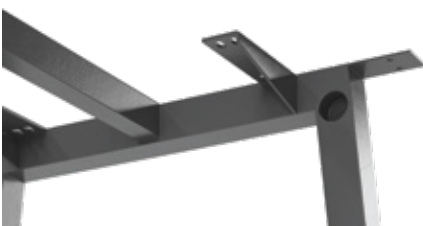

CATÁLOGO 2020

DEAL CREDENZA

- > Base metálica Deal fabricada con perfil de 2 ¼" x ¾" en Cal. 18
- > Ménsulas angulares Cal.14 con preparación para recibir travesaño
- > Soldada con micro alambre y terminada en pintura en polvo electrostática
- > Remates plásticos y niveladores para ajuste de altura
- > Larguero metálico con ranura central para conducción de cableado

MEDIDA SUGERIDA DE CUBIERTA: COLORES DISPONIBLES:

1.50 FR X .60 FO

1.60 FR X .60 FO

1.80 FR X .70 FO

 Gris Claro

 Gris Oxford

 Negro

 Blanco

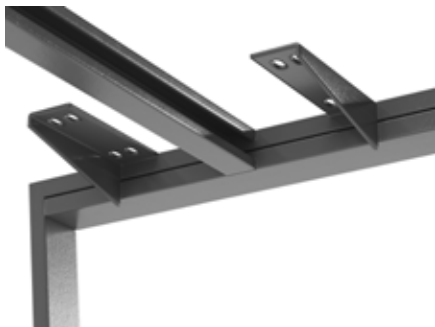

CATÁLOGO 2020

NOVA CREDENZA

- › Base metálica Nova fabricada con perfil de 4 x 1 ½" y 2 x 2" en Cal. 18
- › Ménsulas angulares Cal. 14 con preparación para recibir travesaño
- › Soldada con microalambre y terminada en pintura en polvo electrostática
- › Soporte conector sobre credenza
- › Remates plásticos y niveladores para ajuste de altura
- › Larguero metálico con ranura central para conducción de cableado

MEDIDA SUGERIDA DE CUBIERTA: COLORES DISPONIBLES:

1.50 FR X .70 FO

1.60 FR X .70 FO

1.80 FR X .70 FO

 Gris Claro

 Gris Oxford

 Negro

 Blanco



CATÁLOGO 2020

SQUARE CREDENZA

- > Base metálica Square fabricada con perfil de 2 x 2" y 2 x 1" en Cal. 18
- > Ménsulas angulares Cal. 14 con preparación para recibir travesaño
- > Soldada con microalambre y terminada en pintura en polvo electrostática
- > Soporte conector sobre credenza
- > Remates plásticos y niveladores para ajuste de altura
- > Larguero metálico con ranura central para conducción de cableado

MEDIDA SUGERIDA DE CUBIERTA: COLORES DISPONIBLES:

1.50 FR X .60 FO

1.60 FR X .60 FO

1.80 FR X .70 FO

 Gris Claro

 Gris Oxford

 Negro

 Blanco



CATÁLOGO 2020

STAPLE CREDENZA

- > Base metálica Staple fabricada con perfill de 2 x 2" en Cal. 18
- > Ménsulas angulares Cal. 14 con preparación para recibir travesaño
- > Soldada con microalambre y terminada en pintura en polvo electrostática
- > Soporte conector sobre credenza
- > Remates plásticos y niveladores para ajuste de altura
- > Larguero metálico con ranura central para conducción de cableado

MEDIDA SUGERIDA DE CUBIERTA: COLORES DISPONIBLES:

1.50 FR X .60 FO

1.60 FR X .60 FO

1.80 FR X .70 FO

 Gris Claro

 Gris Oxford

 Negro

 Blanco



CATÁLOGO 2020

ROME CREDENZA



- > Base metálica Rome fabricada con perfil de 2 x 2" en Cal. 18
- > Ménsulas angulares Cal. 14 con preparación para recibir travesaño
- > Soldada con microalambre y terminada en pintura en polvo electrostática
- > Remates plásticos y niveladores para ajuste de altura
- > Larguero metálico con ranura central para conducción de cableado

MEDIDA SUGERIDA DE CUBIERTA:

COLORES DISPONIBLES:

1.50 FR X .60 FO

1.60 FR X .60 FO

1.80 FR X .70 FO

 Gris Claro

 Gris Oxford

 Negro

 Blanco

CATÁLOGO 2020

ONIX CREDENZA

- > Base metálica Ónix fabricada con perfil de 3 x 1 ½" en Cal. 18
- > Ménsulas angulares Cal. 14 con preparación para recibir travesaño
- > Soldada con micro alambre y terminada en pintura en polvo electrostática
- > Remates plásticos y niveladores para ajuste de altura
- > Larguero metálico con ranura central para conducción de cableado

MEDIDA SUGERIDA DE CUBIERTA: COLORES DISPONIBLES:

1.50 FR X .60 FO

1.60 FR X .60 FO

1.80 FR X .70 FO

 Gris Claro

 Gris Oxford

 Negro

 Blanco

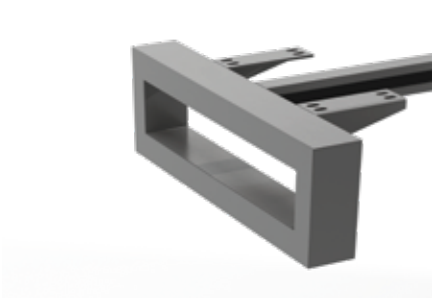
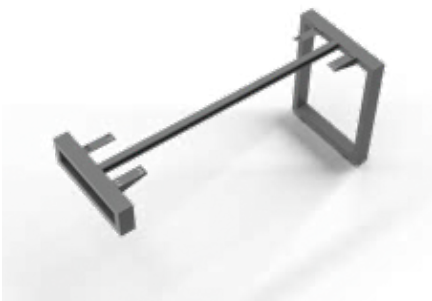





CATÁLOGO 2020

ONIX BENCH

- › Base metálica Ónix fabricada con perfil de 3x1 ½" en Cal. 18
- › Ménsulas angulares Cal. 14 con preparación para recibir travesaño
- › Soldada con micro alambre y terminada en pintura en polvo electrostática
- › Remates plásticos y niveladores para ajuste de altura
- › Larguero metálico con ranura central para conducción de cableado

MEDIDA SUGERIDA DE CUBIERTA: COLORES DISPONIBLES:

1.20 FR X 1.20 FO
2.40 FR X 1.20 FO
3.00 FR X 1.20 FO
3.60 FR X 1.20 FO
4.50 FR X 1.20 FO
4.80 FR X 1.20 FO
6.00 FR X 1.20 FO

 Gris Claro
 Gris Oxford
 Negro
 Blanco

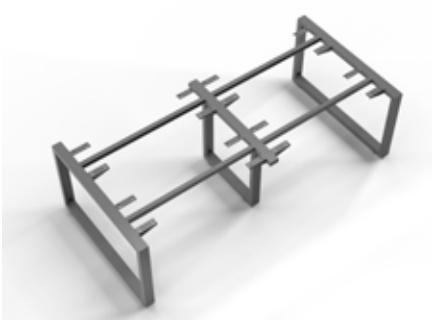





CATÁLOGO 2020

DEAL BENCH

- › Base metálica Deal fabricada con perfil de 2 ¼" x ¾" en Cal. 18
- › Ménsulas angulares Cal.14 con preparación para recibir travesaño
- › Soldada con micro alambre y terminada en pintura en polvo electrostática
- › Remates plásticos y niveladores para ajuste de altura
- › Larguero metálico con ranura central para conducción de cableado

MEDIDA SUGERIDA DE CUBIERTA: COLORES DISPONIBLES:

1.20 FR X 1.20 FO
2.40 FR X 1.20 FO
3.00 FR X 1.20 FO
3.60 FR X 1.20 FO
4.50 FR X 1.20 FO
4.80 FR X 1.20 FO
6.00 FR X 1.20 FO

 Gris Claro
 Gris Oxford
 Negro
 Blanco

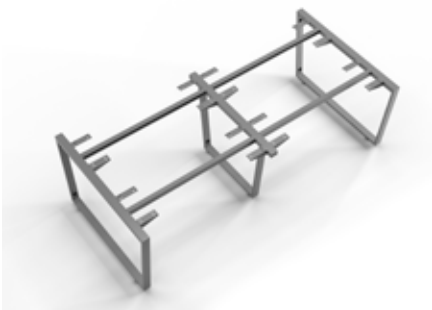





CATÁLOGO 2020

ROME BENCH

- › Base metálica Rome fabricada con perfil de 2 x 2" en Cal. 18
- › Ménsulas angulares Cal. 14 con preparación para recibir travesaño
- › Soldada con microalambre y terminada en pintura en polvo electrostática
- › Remates plásticos y niveladores para ajuste de altura
- › Larguero metálico con ranura central para conducción de cableado

MEDIDA SUGERIDA DE CUBIERTA: COLORES DISPONIBLES:

1.20 FR X 1.20 FO
2.40 FR X 1.20 FO
3.00 FR X 1.20 FO
3.60 FR X 1.20 FO
4.50 FR X 1.20 FO
4.80 FR X 1.20 FO
6.00 FR X 1.20 FO

 Gris Claro
 Gris Oxford
 Negro
 Blanco







CATÁLOGO 2020

SQUARE BENCH

- › Base metálica Square fabricada con perfil de 2 x 2" y 2 x 1" en Cal. 18
- › Ménsulas angulares Cal. 14 con preparación para recibir travesaño
- › Soldada con microalambre y terminada en pintura en polvo electrostática
- › Remates plásticos y niveladores para ajuste de altura
- › Larguero metálico con ranura central para conducción de cableado

MEDIDA SUGERIDA DE CUBIERTA: COLORES DISPONIBLES:

1.20 FR X 1.20 FO
2.40 FR X 1.20 FO
3.00 FR X 1.20 FO
3.60 FR X 1.20 FO
4.50 FR X 1.20 FO
4.80 FR X 1.20 FO
6.00 FR X 1.20 FO

 Gris Claro
 Gris Oxford
 Negro
 Blanco

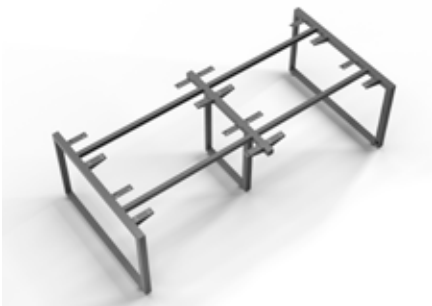





CATÁLOGO 2020

STAPLE BENCH

- › Base metálica Staple fabricada con perfil de 2 x 2" en Cal. 18
- › Ménsulas angulares Cal. 14 con preparación para recibir travesaño
- › Soldada con microalambre y terminada en pintura en polvo electrostática
- › Remates plásticos y niveladores para ajuste de altura
- › Larguero metálico con ranura central para conducción de cableado

MEDIDA SUGERIDA DE CUBIERTA: COLORES DISPONIBLES:

1.20 FR X 1.20 FO
2.40 FR X 1.20 FO
3.00 FR X 1.20 FO
3.60 FR X 1.20 FO
4.50 FR X 1.20 FO
4.80 FR X 1.20 FO
6.00 FR X 1.20 FO

 Gris Claro
 Gris Oxford
 Negro
 Blanco







CATÁLOGO 2020

NOVA BENCH

- › Base metálica Nova fabricada con perfil de 4 x 1 ½" y 2 x 2" en Cal. 18
- › Ménsulas angulares Cal. 14 con preparación para recibir travesaño
- › Soldada con microalambre y terminada en pintura en polvo electrostática
- › Remates plásticos y niveladores para ajuste de altura.
- › Larguero metálico con ranura central para conducción de cableado

MEDIDA SUGERIDA DE CUBIERTA: COLORES DISPONIBLES:

1.20 FR X 1.20 FO
2.40 FR X 1.20 FO
3.00 FR X 1.20 FO
3.60 FR X 1.20 FO
4.50 FR X 1.20 FO
4.80 FR X 1.20 FO
6.00 FR X 1.20 FO

 Gris Claro
 Gris Oxford
 Negro
 Blanco



CATÁLOGO 2020





PIATTO

- › Base Piatto fabricada en estructura metálica tubular de 4" Cal. 18
- › Placa soporte para cubierta de 1/4 de espesor
- › Soporte inferior metálico con vista decorativa de MDF pintado
- › Niveladores para ajuste de altura

MEDIDA SUGERIDA DE CUBIERTA:

COLORES DISPONIBLES:

.90 DIÁMETRO
1.00 DIÁMETRO
1.10 DIÁMETRO
1.20 DIÁMETRO

 Gris Claro
 Gris Oxford
 Negro
 Blanco

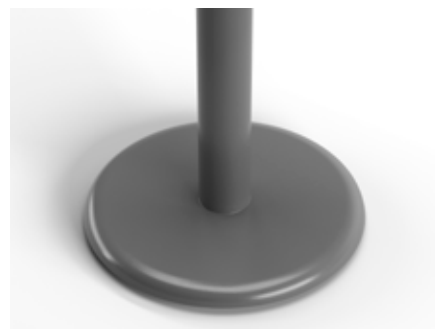
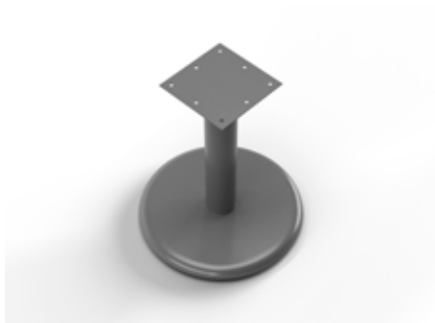

CATÁLOGO 2020

DAEWON

- › Base Daewon fabricada en estructura metálica tubular de 3" en Cal 18
- › Placa soporte para cubierta de 1/4 de espesor
- › Base en forma de estrella de .80 cm de punta a punta
- › Niveladores para ajuste de altura

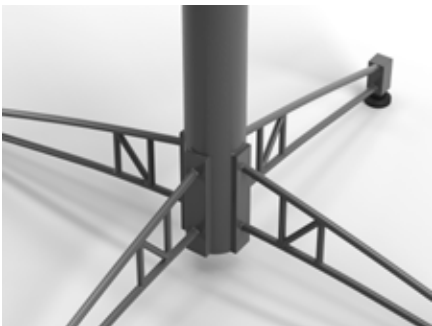

MEDIDA SUGERIDA DE CUBIERTA:

COLORES DISPONIBLES:

.80 x .80 M

.90 x .90 M

1.00 X 1.00 M

1.10 X 1.10 M

1.20 X 1.20 M

 Gris Claro

 Gris Oxford

 Negro

 Blanco

CATÁLOGO 2020

CROCE

- > Base Croce fabricada en estructura metálica tubular de 3" en Cal 18
- > Placa soporte para cubierta de 1/4 de espesor
- > Base en forma de estrella de .80 cm de punta a punta
- > Niveladores para ajuste de altura

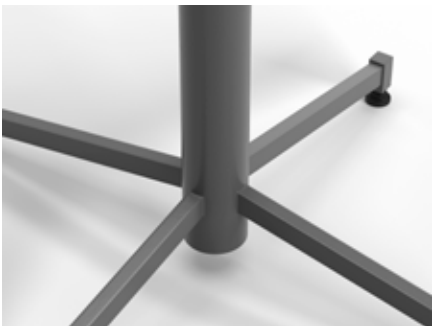

MEDIDA SUGERIDA DE CUBIERTA:

COLORES DISPONIBLES:

.80 x .80 M

.90 x .90 M

1.00 X 1.00 M

1.10 X 1.10 M

1.20 X 1.20 M

 Gris Claro

 Gris Oxford

 Negro

 Blanco

BASES METÁLICAS

CATÁLOGO 2020

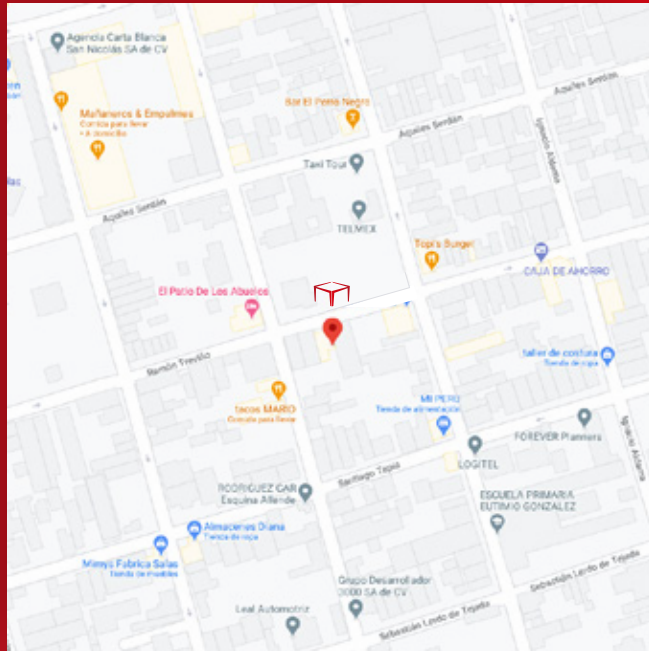

VENTAS

Ramon Treviño 212 — Colonia Centro
San Nicolás de los Garza, Nuevo León — Mx. 66400

WWW.METALYA.MX
VENTAS@METALYA.MX
TGARZA@METALYA.MX
(81) 8479 0480



METALYA